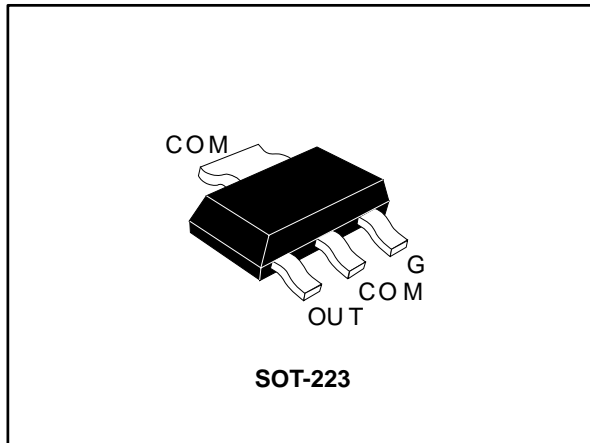

Overvoltage protected AC switch (ACS™)

Datasheet - production data

Description

The ACS108-8TN belongs to the AC switch range (built with A.S.D.® technology). This high performance switch can control a load of up to 0.8 A.

The ACS108-8TN switch includes an overvoltage crowbar structure to absorb the inductive turn-off energy, and a gate level shifter driver to separate the digital controller from the main switch. It is triggered with a negative gate current flowing out of the gate pin.

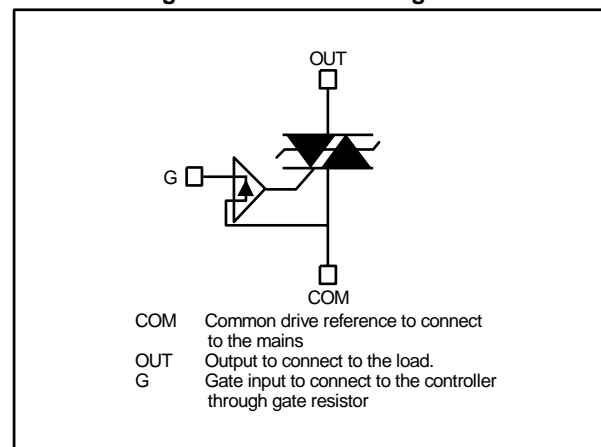
Figure 1: Functional diagram

Features

- Enables equipment to meet IEC 61000-4-5 surge with overvoltage crowbar technology
- High noise immunity against static dV/dt and IEC 61000-4-4 burst
- Needs no external protection snubber or varistor
- Interfaces directly with the microcontroller ECOPACK®2 and RoHS compliant component

Applications

- Alternating current on/off static switching in appliances and industrial control systems
- Driving low power high inductive or resistive loads like:
 - Relay, valve, solenoid, dispenser
 - Pump, fan, low power motor, door lock
 - lamp

Table 1: Device summary

Symbol	Value
$I_{T(RMS)}$	0.8 A
V_{DRM}/V_{RRM}	800 V
I_{GT}	5 mA

1 Characteristics

Table 2: Absolute ratings (limiting values)

Symbol	Parameter		Value	Unit	
$I_{T(RMS)}$	RMS on-state current (180 ° conduction angle)		$T_{tab} = 104\text{ °C}$	0.8	A
I_{TSM}	Non repetitive surge peak on-state current	$t_p = 16.7\text{ ms}$	$T_j\text{ initial} = 25\text{ °C}$	13.7	A
		$t_p = 20\text{ ms}$		13	
I^2t	I^2t value for fusing	$t_p = 10\text{ ms}$	$T_j = 25\text{ °C}$	1.1	A ² s
V_{RRM} / V_{DRM}	Repetitive peak off-state voltage		$T_j = 125\text{ °C}$	800	V
di/dt	Critical rate of rise of on-state current	$I_G = 2 \times I_{GT}$, $t_r \leq 100\text{ ns}$	$f = 120\text{ Hz}$	100	A/ μ s
$V_{pp}^{(1)}$	Non repetitive peak pulse line voltage		$T_j = 25\text{ °C}$	2	kV
I_{GM}	Peak gate current	$t_p = 20\text{ }\mu$ s	$T_j = 125\text{ °C}$	1	A
V_{GM}	Peak positive gate voltage		$T_j = 125\text{ °C}$	10	V
$P_{G(AV)}$	Average gate power dissipation		$T_j = 125\text{ °C}$	0.1	W
T_{stg}	Storage junction temperature range			-40 to +150	°C
T_j	Maximum operating junction temperature range			-40 to +125	°C

Notes:

⁽¹⁾According to test described by IEC 61000-4-5 standard and test per [Figure 18](#).

Table 3: Electrical characteristics ($T_j = 25\text{ °C}$ unless otherwise specified)

Symbol	Test Conditions	Quadrant		Value	Unit
$I_{GT}^{(1)}$	$V_{OUT} = 12\text{ V}$, $R_L = 33\text{ }\Omega$	II - III	Max.	5	mA
V_{GT}		II - III	Max.	1	V
V_{GD}	$V_{OUT} = V_{DRM}$, $R_L = 3.3\text{ k}\Omega$, $T_j = 125\text{ °C}$	II - III	Min.	0.15	V
I_H	$I_T = 100\text{ mA}$, gate open		Max.	10	mA
I_L	$I_G = 1.2 \times I_{GT}$		Max.	20	mA
dV/dt	$V_D = 402\text{ V}$, gate open, $T_j = 125\text{ °C}$		Max.	600	V/ μ s
	$V_D = 536\text{ V}$, gate open, $T_j = 125\text{ °C}$			300	
$(di/dt)_c$	$(di/dt)_c < 15\text{ V}/\mu$ s, turn-off time $\leq 20\text{ ms}$, $T_j = 125\text{ °C}$		Min.	0.8	A/ms
V_{CL}	$I_{CL} = 1\text{ mA}$, $t_p = 1\text{ ms}$, $T_j = 125\text{ °C}$		Min.	850	V

Notes:

⁽¹⁾Minimum I_{GT} is guaranteed at 10% of I_{GT} max.

Table 4: Static electrical characteristics

Symbol	Test conditions			Value	Unit
$V_{TM}^{(1)}$	$I_{TM} = 1.1 \text{ A}$, $t_p = 380 \mu\text{s}$	$T_j = 25 \text{ }^\circ\text{C}$	Max.	1.3	V
V_{to}	Threshold voltage	$T_j = 125 \text{ }^\circ\text{C}$	Max.	0.85	V
R_D	Dynamic resistance	$T_j = 125 \text{ }^\circ\text{C}$	Max.	350	m Ω
I_{DRM}	$V_{OUT} = V_{DRM} = V_{RRM}$	$T_j = 25 \text{ }^\circ\text{C}$	Max.	2	μA
I_{RRM}		$T_j = 125 \text{ }^\circ\text{C}$		0.2	mA

Notes:

(1)For both polarities

Table 5: Thermal resistance

Symbol	Parameter	Value	Unit
$R_{th(j-t)}$	Junction to tab (AC)	Max.	25
$R_{th(j-a)}$	Junction to ambient ($S_{cu} = 5 \text{ cm}^2$)	Typ.	60

1.1 Characteristics (curves)

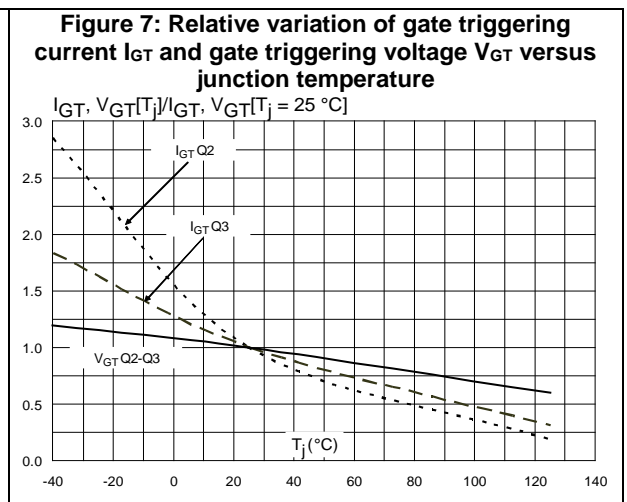
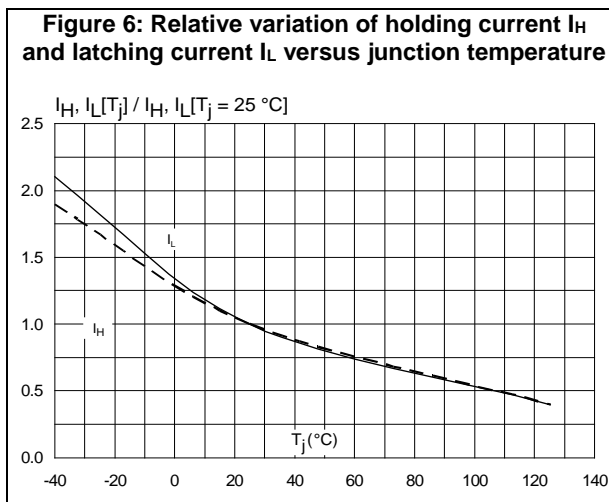
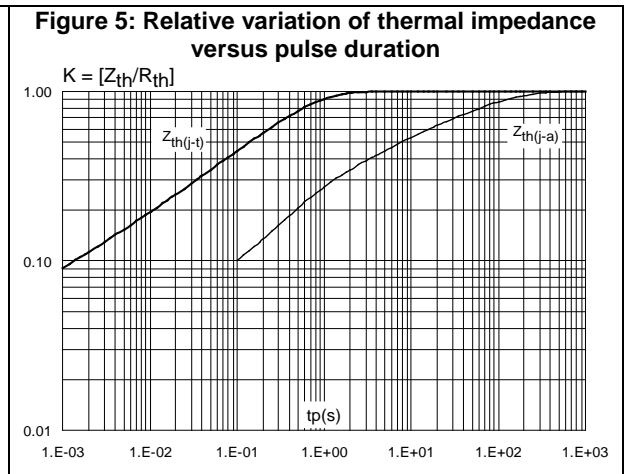
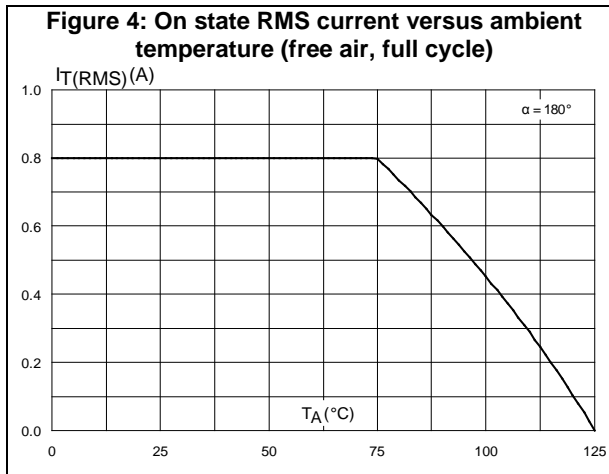
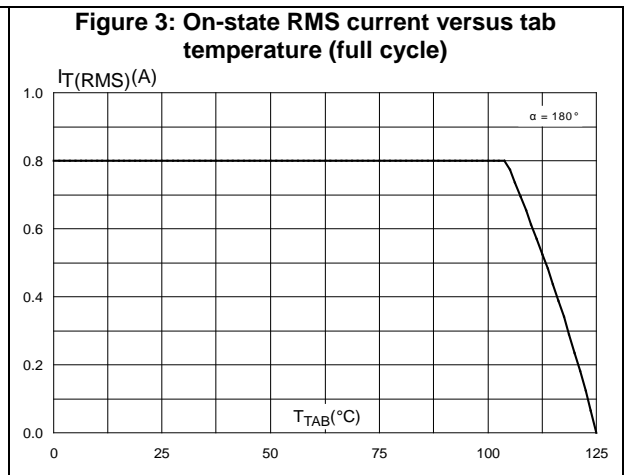
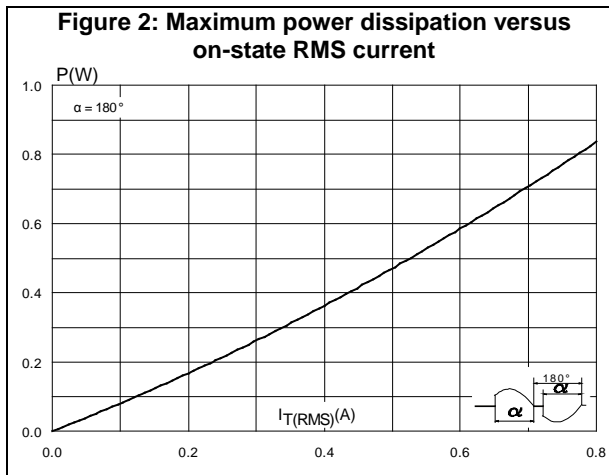

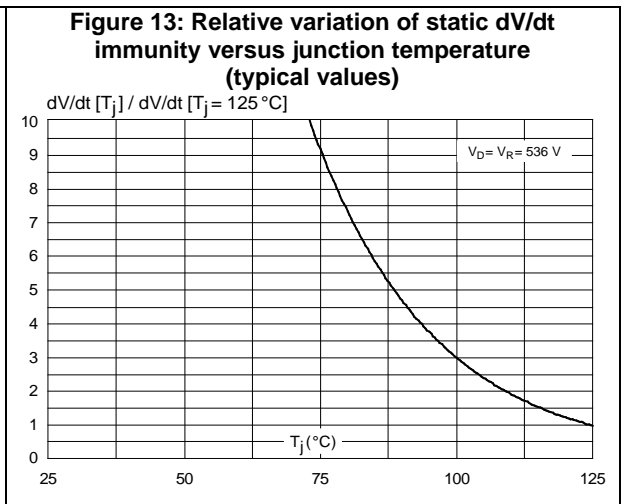
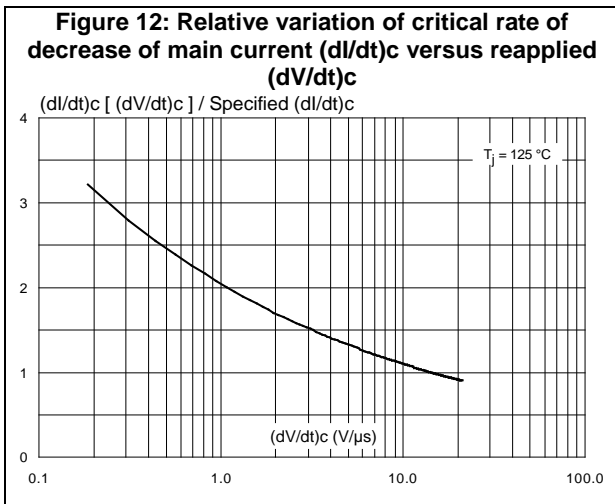
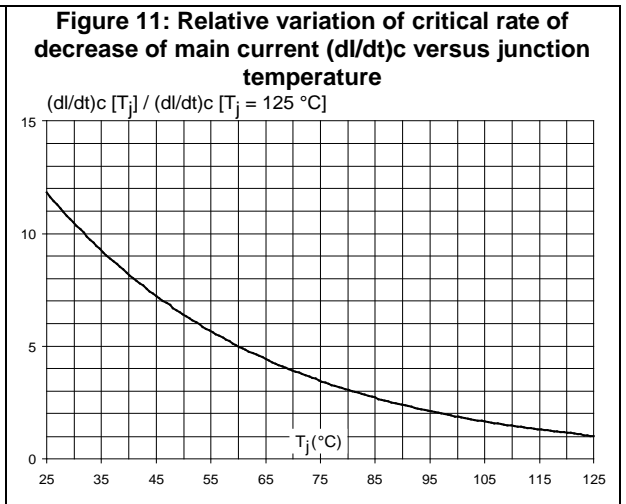
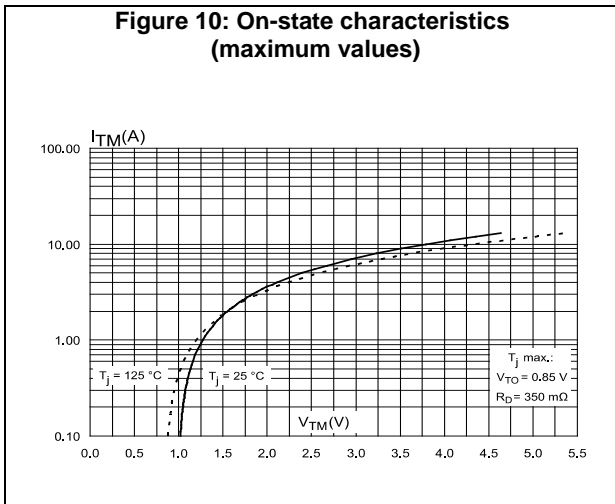
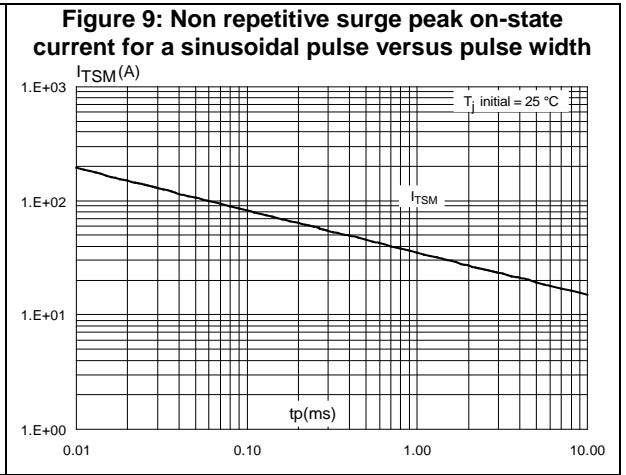
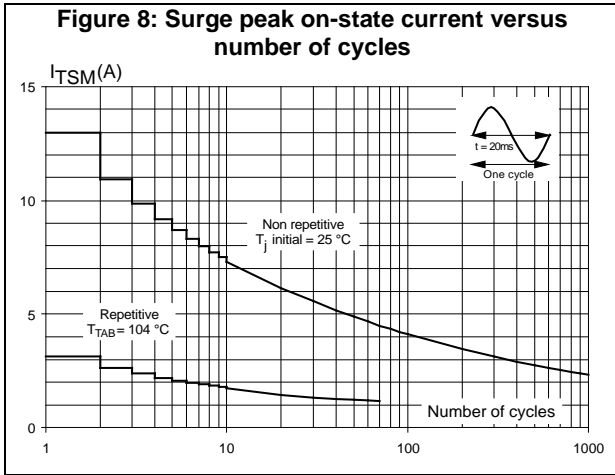

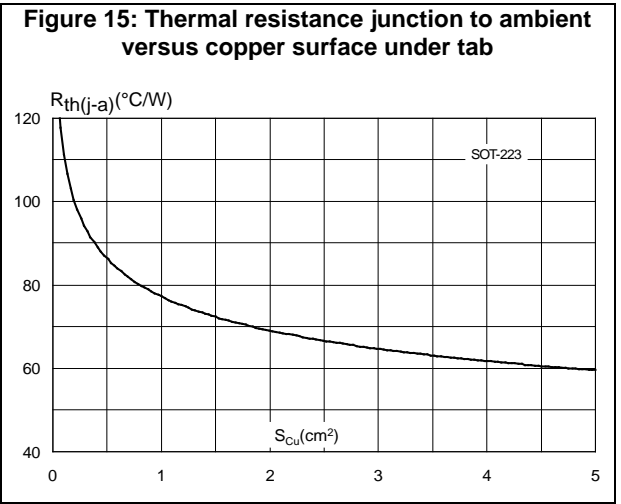
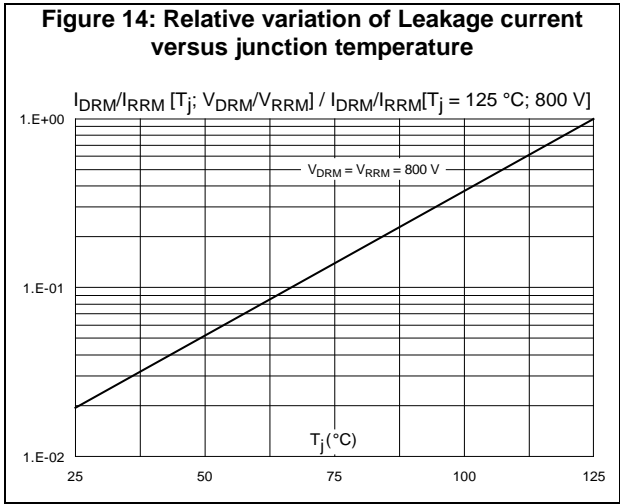

2 Alternating current mains switch - basic application

The ACS108-8TN switch is triggered by a negative gate current flowing from the gate pin G. The switch can be driven directly by the digital controller through a resistor as shown in [Figure 16: "Typical application schematic"](#).

Thanks to its over-voltage protection and turn-off commutation performance, the ACS108-8TN switch can drive a small power high inductive load with neither varistor nor additional turn-off snubber.

Figure 16: Typical application schematic

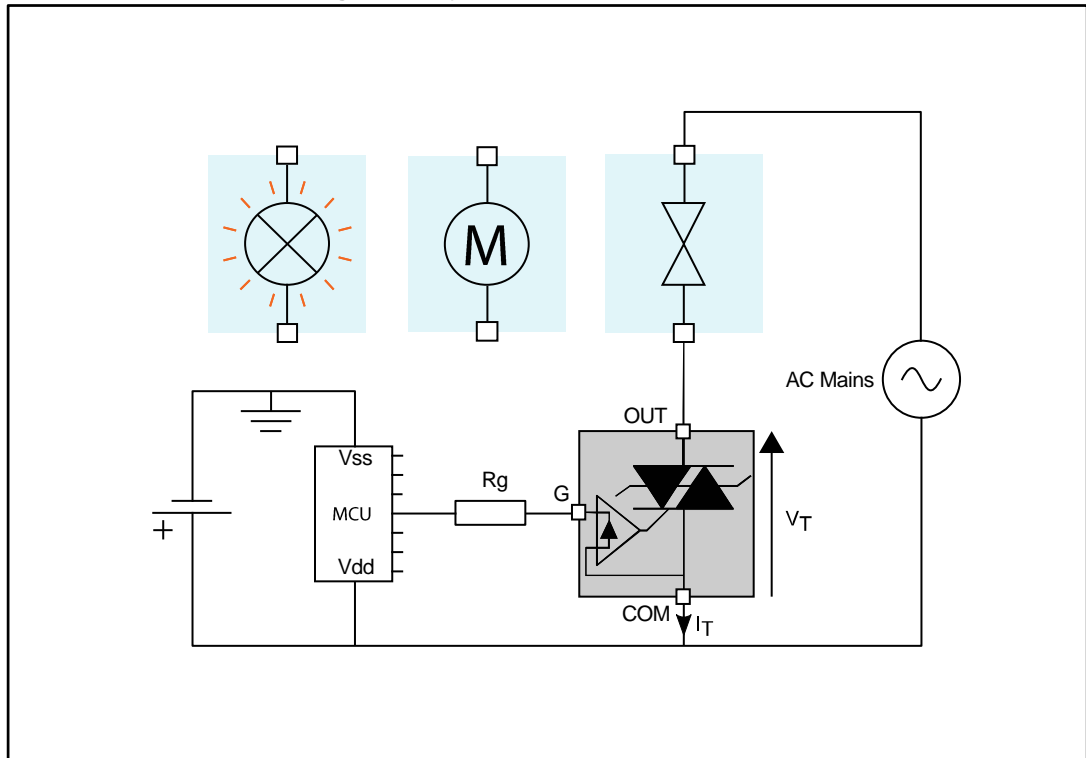

2.1 Protection against overvoltage: the best choice is ACS

In comparison with standard Triacs the ACS108-8TN is overvoltage self-protected, as specified by the new parameter V_{CL} . This feature is useful in two operating conditions: in case of turn-off of very inductive load, and in case of surge voltage that can occur on the electrical network.

2.1.1 High inductive load switch-off: turn-off over-voltage clamping

With high inductive and low rms current loads the rate of decrease of the current is very low. An overvoltage can occur when the gate current is removed and the OUT current is lower than I_H .

As shown in *Figure 17*, at the end of the last conduction half-cycle, the load current decreases ①. The load current reaches the holding current level I_H ②, and the ACS turns off ③. An inductive load (up to 15 H) reacts as a current generator and an overvoltage is created, which is clamped by the ACS ④. The current flows through the ACS avalanche and decreases linearly to zero. During this time, the voltage across the switch is limited to the clamping voltage V_{CL} . The energy stored in the inductance of the load is dissipated in the clamping section that is designed for this purpose. When the energy has been dissipated, the ACS voltage falls back to the mains voltage value (230 V RMS, 50 Hz) ⑤.

Figure 17: Switching off of a high inductive load - typical clamping capability of ACS108-8TN

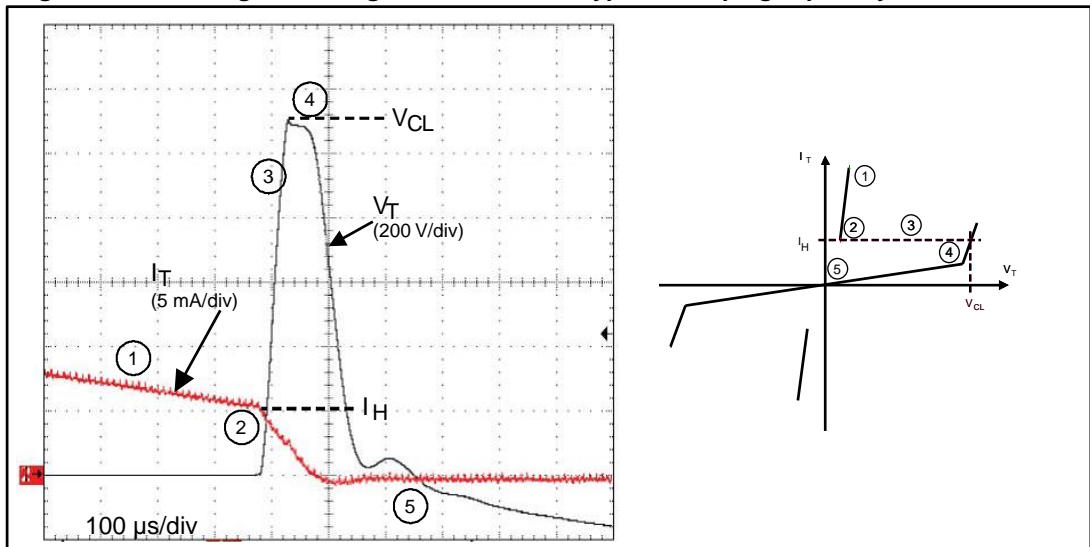

2.1.2 Alternating current mains transient voltage ruggedness

The ACS108-8TN switch is able to withstand safely the AC mains transients either by clamping the low energy spikes or by breaking-over when subjected to high energy shocks, even with high turn-on current rises.

The test circuit shown in [Figure 18](#) is representative of the final ACS108-8TN application, and is also used to test the AC switch according to the IEC 61000-4-5 standard conditions. Thanks to the load limiting the current, the ACS108-8TN switch withstands the voltage spikes up to 2 kV above the peak mains voltage. The protection is based on an overvoltage crowbar technology. Actually, the ACS108-8TN breaks over safely as shown in [Figure 19](#). The ACS108-8TN recovers its blocking voltage capability after the surge (switch off back at the next zero crossing of the current).

Such non-repetitive tests can be done 10 times on each AC mains voltage polarity.

Figure 18: Overvoltage ruggedness test circuit for resistive and inductive loads, $T_{amb} = 25\text{ }^{\circ}\text{C}$ (conditions equivalent to IEC 61000-4-5 standard)

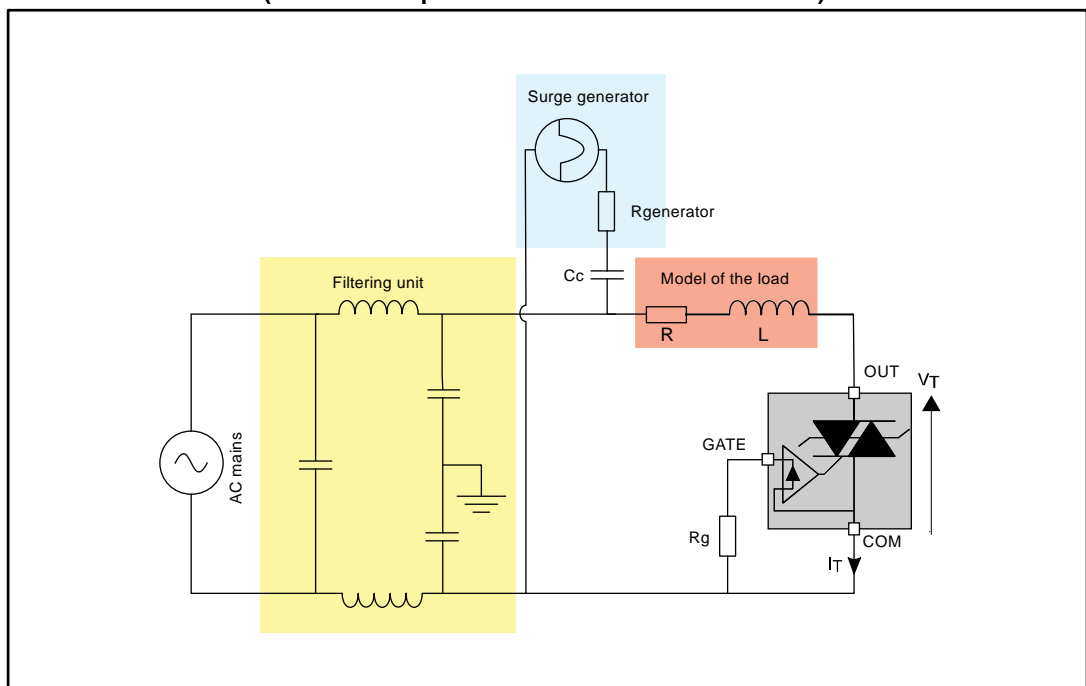

$R = 150\ \Omega$, $L = 5\ \mu\text{H}$, $V_{pp} = 2\ \text{kV}$ (Surge Generator), $R_g = 220\ \Omega$, AC mains = 230 V_{RMS} 50 Hz, $C_c = 18\ \mu\text{F}$.

Figure 19: Typical current and voltage waveforms across the ACS108-8TN (+2 kV surge, IEC 61000-4-5 standard)

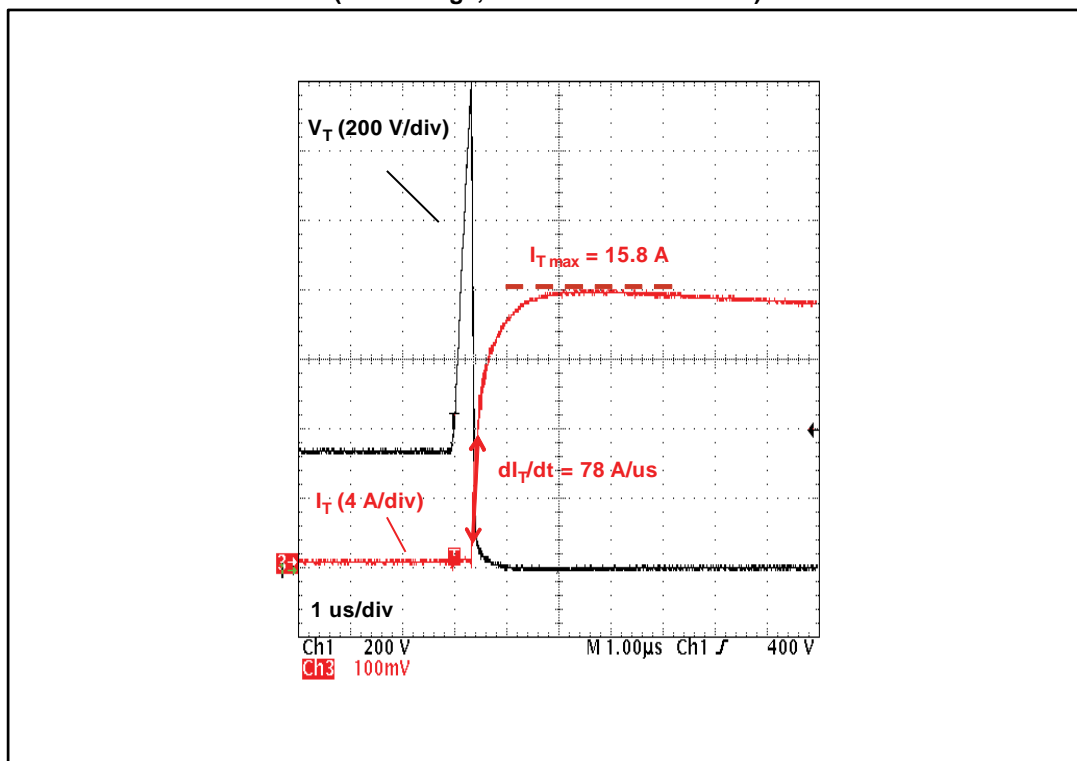

3 Package information

In order to meet environmental requirements, ST offers these devices in different grades of ECOPACK® packages, depending on their level of environmental compliance. ECOPACK® specifications, grade definitions and product status are available at: www.st.com. ECOPACK® is an ST trademark.

- Epoxy meets UL94, V0
- Lead-free packages

3.1 SOT-223 package information

Figure 20: SOT-223 package outline

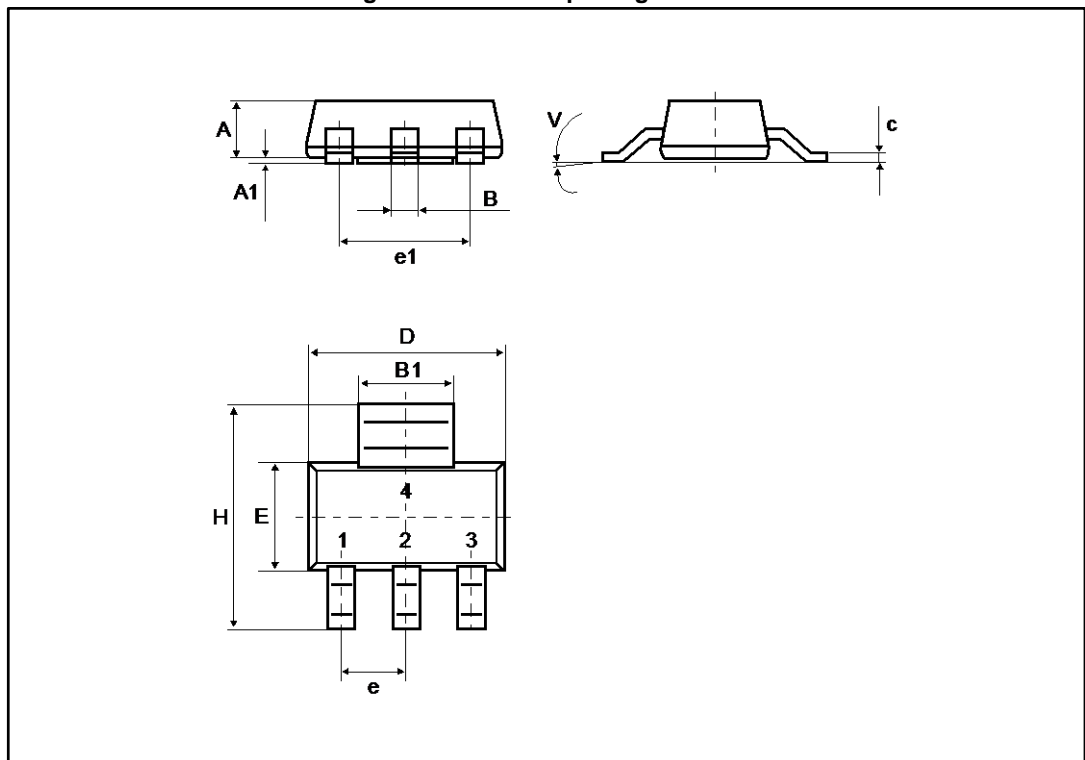
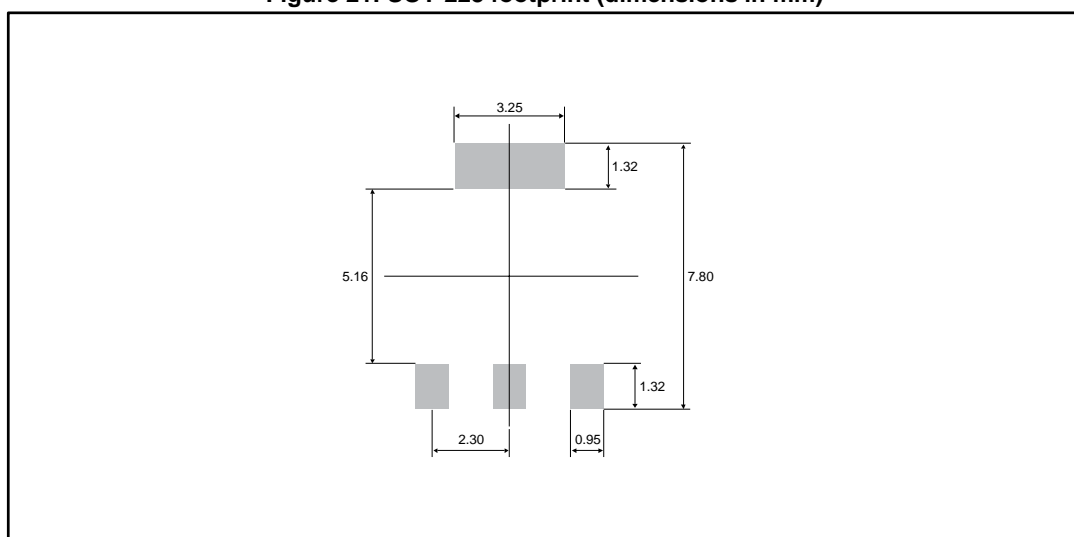

Table 6: SOT-223 package mechanical data

Ref.	Dimensions					
	Millimeters			Inches		
	Min.	Typ.	Max.	Min.	Typ.	Max.
A			1.80			0.071
A1		0.02	0.10		0.001	0.004
B	0.60	0.70	0.85	0.024	0.027	0.033
B1	2.90	3.00	3.15	0.114	0.118	0.124
c	0.24	0.26	0.35	0.009	0.010	0.014
D	6.30	6.50	6.70	0.248	0.256	0.264
e		2.3			0.090	
e1		4.6			0.181	
E	3.30	3.50	3.70	0.130	0.138	0.146
H	6.70	7.00	7.30	0.264	0.276	0.287
V	10° max.					

Figure 21: SOT-223 footprint (dimensions in mm)



4 Ordering information

Figure 22: Ordering information scheme

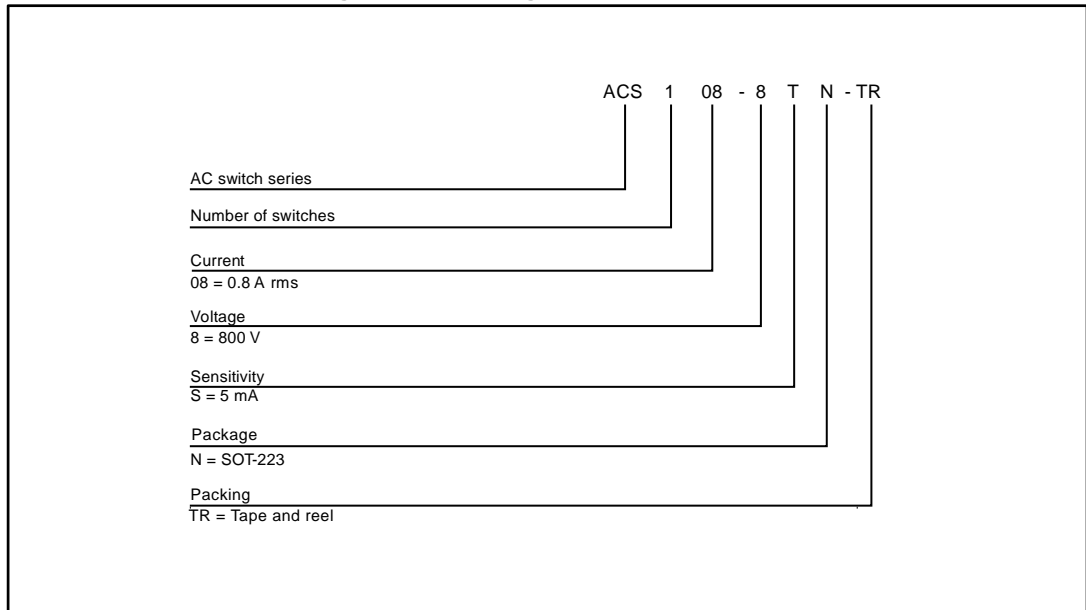

Table 7: Ordering information

Order code	Marking	Package	Weight	Base qty.	Delivery mode
ACS108-8TN-TR	ACS1088T	SOT-223	0.11 g	1000	Tape and reel

5 Revision history

Table 8: Document revision history

Date	Revision	Changes
02-Jun-2016	1	Initial release.

IMPORTANT NOTICE – PLEASE READ CAREFULLY

STMicroelectronics NV and its subsidiaries ("ST") reserve the right to make changes, corrections, enhancements, modifications, and improvements to ST products and/or to this document at any time without notice. Purchasers should obtain the latest relevant information on ST products before placing orders. ST products are sold pursuant to ST's terms and conditions of sale in place at the time of order acknowledgement.

Purchasers are solely responsible for the choice, selection, and use of ST products and ST assumes no liability for application assistance or the design of Purchasers' products.

No license, express or implied, to any intellectual property right is granted by ST herein.

Resale of ST products with provisions different from the information set forth herein shall void any warranty granted by ST for such product.

ST and the ST logo are trademarks of ST. All other product or service names are the property of their respective owners.

Information in this document supersedes and replaces information previously supplied in any prior versions of this document.

© 2016 STMicroelectronics – All rights reserved

Mouser Electronics

Authorized Distributor

Click to View Pricing, Inventory, Delivery & Lifecycle Information:

[STMicroelectronics:](#)

[ACS108-8TN-TR](#)